

## Operating Cost Comparison: Lithium battery forklift **vs.** Lead-acid battery forklift **vs.** IC forklift

The advantages of HELI lithium battery forklift trucks are more prominent in the life cycle cost. Compared with internal combustion forklift truck, lithium battery forklift truck has the advantages of no noise, no pollution, small vibration and simple operation. Compared with the lead-acid battery forklift truck, lithium battery forklift has the characteristics of fast charging and charging at any time, which is more suitable for multi shift operation. Besides, HELI lithium battery forklift is maintenance free, high power conversion efficiency, and economical overall operation cost.

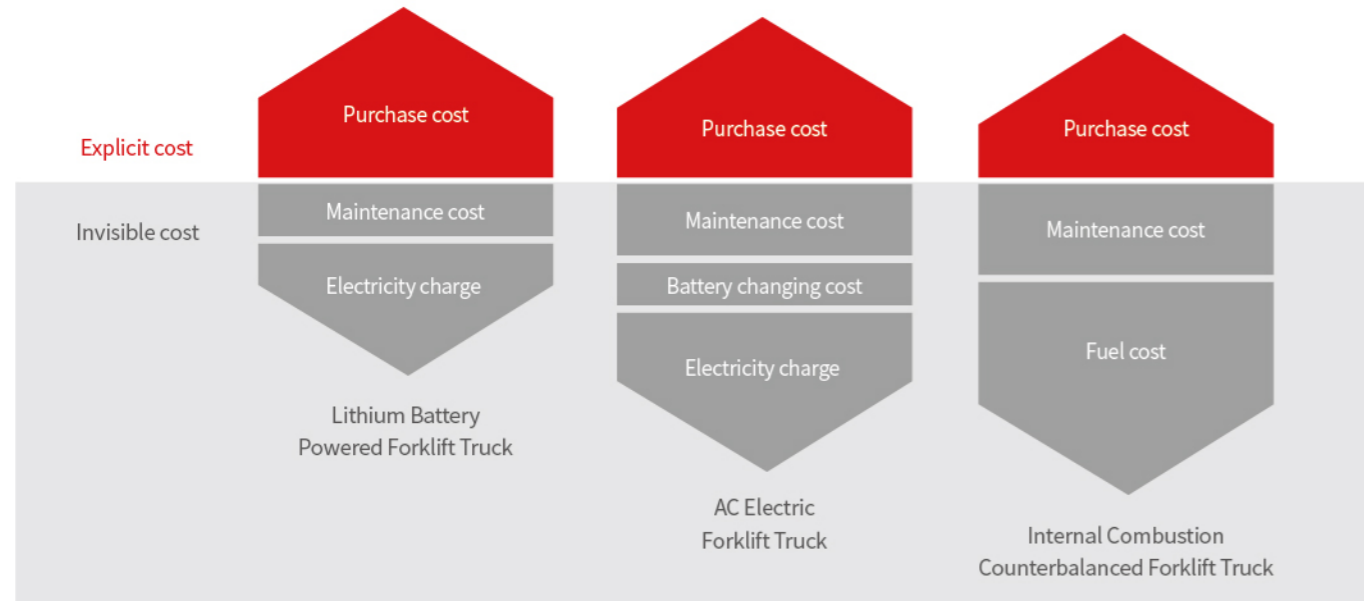

## CPD 20/25/30/35

GB2LI-H / GB2LI-M / GB3LI-S / GB3LI-M



**4000-7000 lbs**  
G2 Series Lithium-ion Battery  
Forklift Truck

\* Details of specifications and equipment are based on information available at time of printing and may change without notice.

**HELI AMERICA INC**

ADD: 4025 Welcome All Road, Suite 150 Atlanta, GA30349, U.S.A.  
E-MAIL: heli@heliforkliftamerica.com  
TEL: 404-242-3288



HELI

Fearless of Any Rough Application,  
**HELI New Series Lithium Forklift,**  
Your Best Choice





## Powerful Performance, High Efficiency

Customers can freely choose from the 3 different configurations: S, M, H. Especially M and H configurations are comparable with internal combustion trucks in terms of comprehensive performance.

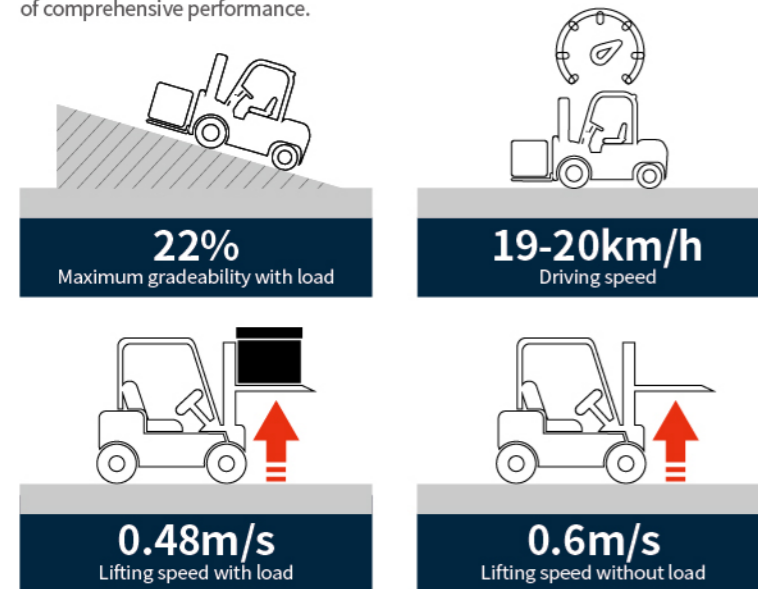

Note: the data displayed are all based on the model CPD30-GB2LI-H, and data for other trucks are shown in the table of technical parameters.

## Smart and Safe, Ease In All Aspects

- Steering deceleration: Auto steering deceleration reduces the risk of turning over;
- Steering started by steering wheel: the steering wheel can directly start the steering function and provides the required oil quantity according to the steering wheel speed;
- Color screen instrument: Bilingual (CN/EN) options, full vehicle information at a glance;
- PES Three-speed mode: Choose multiple speed modes according to working conditions, guarantee work efficiency;
- Rear handle with horn switch for safer reversing;
- Lithium battery is automatically heated at low temperature, with excellent low temperature adaptability.

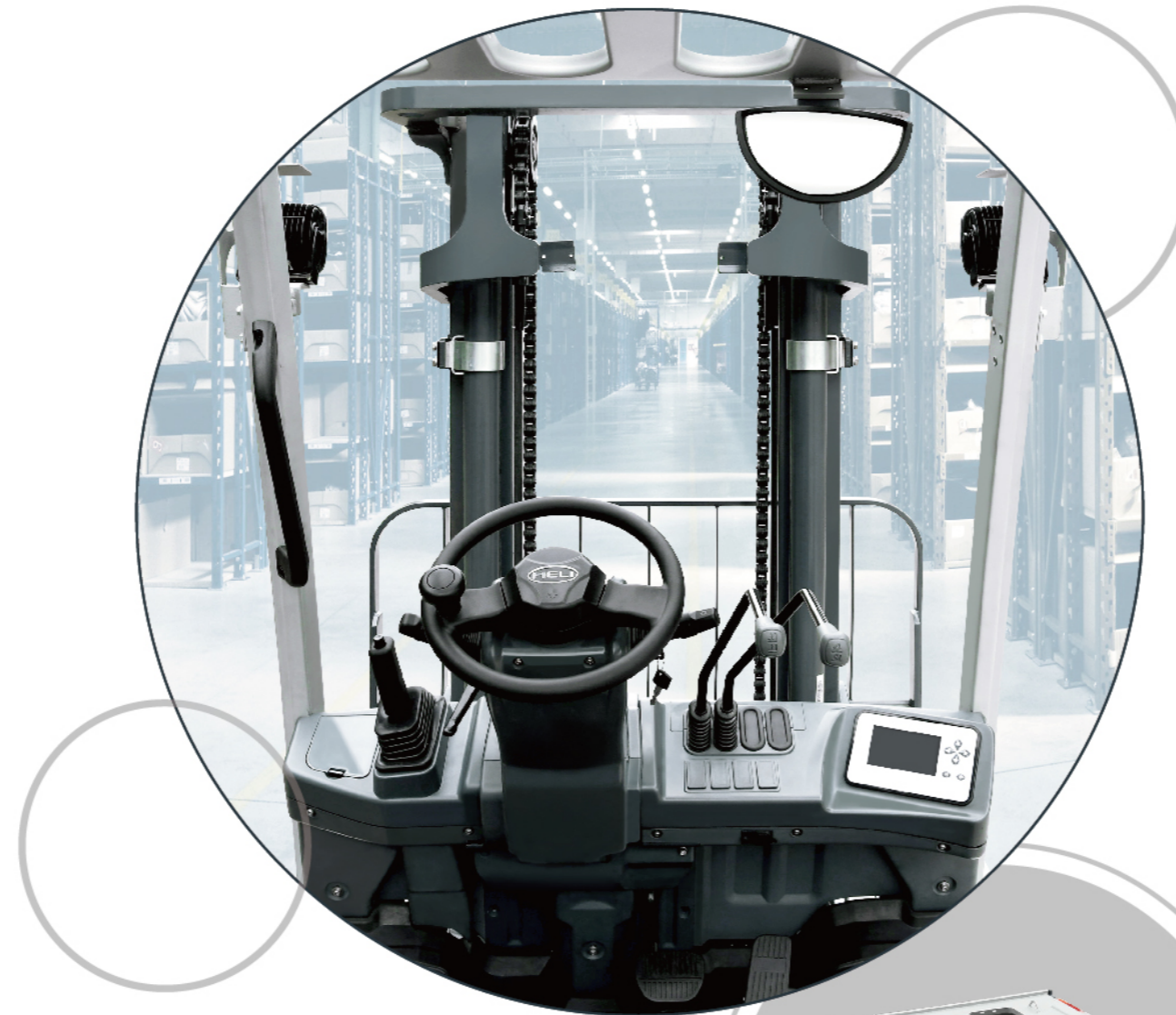
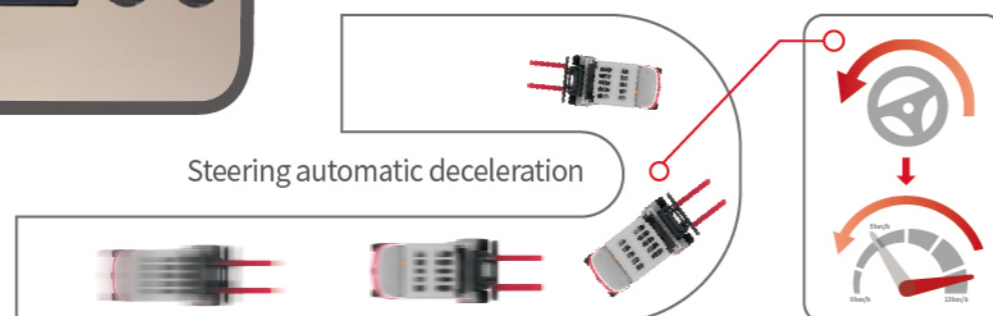

## Optimized Ergonomic Design, Better Driving Comfort



- Optimized mast and pressed overhead guard for improved visibility and safety.
- Ultra-low torque steering gear and lighter steering operation reduces driving fatigue.

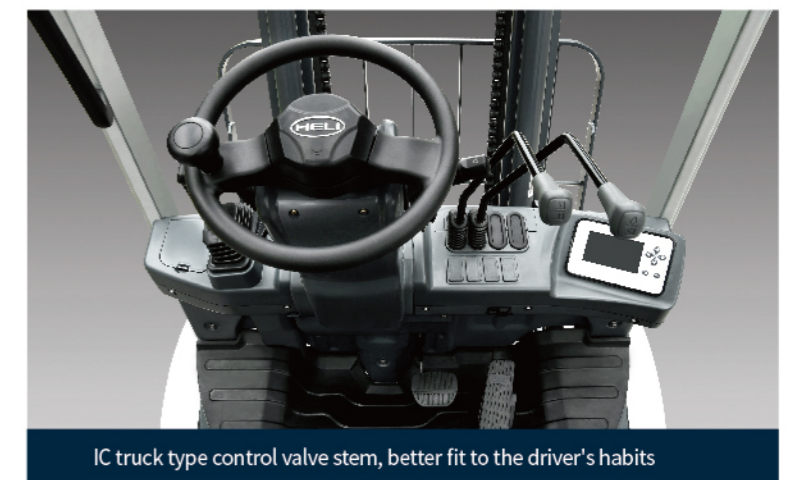



坡度20%

## High Quality & High Reliability

The integrated cast drive axle and reinforced cast steering axle have been proven in the market and are mature and reliable. The mast force optimization design improves the overall performance and effectively ensures the operation safety.

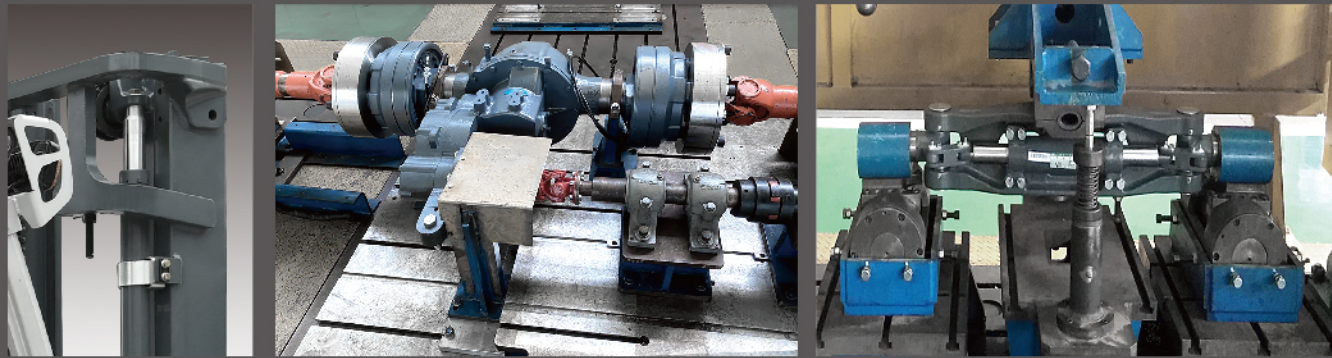

## Centralized Checkpoints, Easy Maintenance

The electrical design is concentrated on the top of lithium battery, and the maintenance points are centralized, which is convenient for inspection and maintenance.

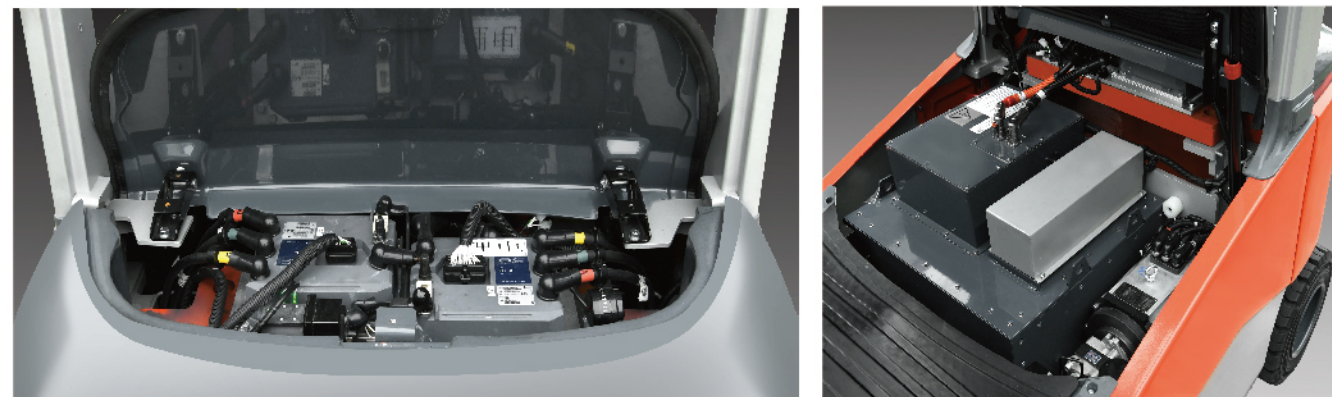

## Tested in Rough Operating Environment



IPX4 waterproof: the vehicle is powered on to simulate a 15min short-time 5000L rainstorm test, and the vehicle can continue to run without failures.



After 10mins wading test, the vehicle has no failure. (Water depth 200mm)



The whole vehicle can be operated alternately in -20°C cold storage for 6 hours and parked in the cold storage for 12 hours without any failure and can continue to work.



The truck passed simulation experiment of bumpy road.

## Lithium Battery Advantages



Seawater immersion test



Extrusion test

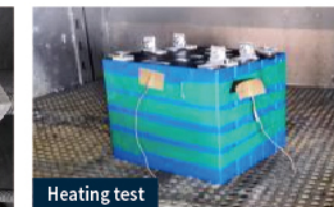

Heating test

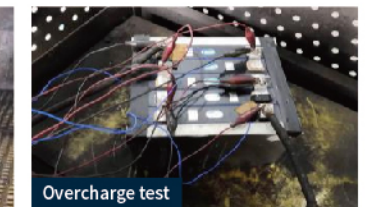

Overcharge test



Temperature cycling test

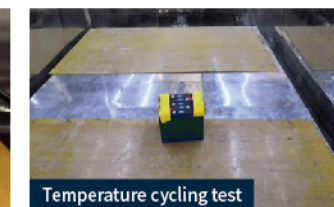

Temperature cycling test



Drop test

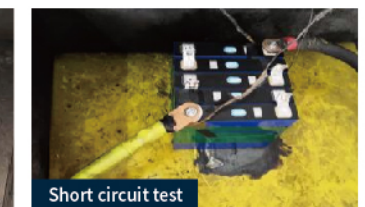

Short circuit test

- The truck selects mature and economical square iron phosphate lithium battery core and module used by large numbers of commercial vehicles;
- The module adopts aluminum alloy plate frame, which is firm, light in weight and has good heat dissipation effect;
- Fast charging: fast charging makes truck gapless operation possible, and it can be filled in 2 hours;
- High efficiency and safety: The charging and discharging efficiency is up to 98%, and temperature of thermal runaway is over 600 °C;
- Low temperature adaptability: Standard configuration of heating function ensures normal operation of low temperature environment;
- Long service life: the normal charging and discharging cycles is more than 3000 times or 5 years, and capacity retention rate is more than 75%;
- Maintenance free: the battery does not need manual maintenance and does not need to add distilled water electrolyte;
- Green and clean: no pollution and zero emission.



Manufacturer and Technical Data																												
Characteristics																												
1.01	Manufacturer	HELI																										
1.02	Model	CPD20		CPD25		CPD20		CPD25		CPD20		CPD25		CPD30		CPD35		CPD30		CPD35		CPD30		CPD35				
1.03	Configuration number	GB2LI-H		GB2LI-H		GB2LI-M/GB3LI-M		GB2LI-M/GB3LI-M		GB3LI-S		GB3LI-S		GB2LI-H		GB2LI-H		GB2LI-M/GB3LI-M		GB2LI-M/GB3LI-M		GB3LI-S		GB3LI-S				
1.04	Rated capacity	Q	kg	lb	2000	4000	2500	5000	2000	4000	2500	5000	2000	4000	2500	5000	3000	6000	3500	7000	3000	6000	3500	7000	3000	6000	3500	7000
1.05	Load center distance	c	mm	in	500	24	500	24	500	24	500	24	500	24	500	24	500	24	500	24	500	24	500	24	500	24	500	24
Weight																												
2.01	Total weight(with/without battery)		kg	lb	3510/3290	7020/6580	3890/3670	7780/7340	3510/3290	7020/6580	3890/3670	7780/7340	3510/3290	7020/6580	3890/3670	7780/7340	4580/4230	9160/8460	5000/4650	1000/9300	4580/4230	9160/8460	5000/4650	1000/9300	4580/4230	9160/8460	5000/4650	1000/9300
Tyres																												
3.01	Tyre type				pneumatic tyre		pneumatic tyre		pneumatic tyre		pneumatic tyre		pneumatic tyre		pneumatic tyre		pneumatic tyre/soild		soild tyre		pneumatic tyre/soild		soild tyre		pneumatic tyre/soild		soild tyre	
3.02	Tyre size, front				7.00-12-14PR												28X9-15-14PR		28x9-15		28x9-15-14PR		28X9-15		28X9-15-14PR		28X9-15	
3.03	Tyre size, rear				18x7-8-14PR												200/50-10											
Dimensions																												
4.01	Height(mast lowered)	h1	mm	in	2000	78.7	2000	78.7	2000	78.7	2000	78.7	2000	78.7	2000	78.7	2070	81.5	2120	83.5	2070	81.5	2120	83.5	2070	81.5	2120	83.5
4.02	Max. height, extended(with backrest)	h4	mm	in	4030	158.7	4030	158.7	4030	158.7	4030	158.7	4030	158.7	4030	158.7	4217	166.0	4217	166.0	4217	166.0	4217	166.0	4217	166.0	4217	166.0
4.03	Overall length(with fork)	l1	mm	in	3352	132.0	3502	137.9	3352	132.0	3502	137.9	3352	132.0	3502	137.9	3639	143.3	3644	143.5	3639	143.3	3644	143.5	3639	143.3	3644	143.5
4.04	Overall length(without fork)	l2	mm	in	3432	135.1	2432	95.7	2432	95.7	2432	95.7	2432	95.7	2432	95.7	2569	101.1	2574	101.3	2569	101.1	2574	101.3	2569	101.1	2574	101.3
4.05	Overall width	b1	mm	in	1160	45.7	1160	45.7	1160	45.7	1160	45.7	1160	45.7	1160	45.7	1225	48.2	1225	48.2	1225	48.2	1225	48.2	1225	48.2	1225	48.2
4.06	Min. outside turning radius	Wa	mm	in	2050	80.7	2050	80.7	2050	80.7	2050	80.7	2050	80.7	2050	80.7	2215	87.2	2215	87.2	2215	87.2	2215	87.2	2215	87.2	2215	87.2
Performance Data																												
5.01	Travel speed(laden/unladen)		km/h	mph	19/20	11.9/12.4	19/20	11.9/12.4	18/19	11.2/11.9	18/19	11.2/11.9	14/15	8.7/9.3	14/15	8.7/9.3	19/20	11.9/12.4	19/20	11.9/12.4	18/19	11.2/11.9	18/19	11.2/11.9	14/15	8.7/9.3	14/15	8.7/9.3
5.02	Lift speed(laden/unladen)		m/s	mph	0.49/0.6	1.1/1.3	0.47/0.6	1.0/1.3	0.46/0.56	1.0/1.2	0.44/0.56	1.0/1.2	0.38/0.49	0.8/1.1	0.35/0.49	0.8/1.1	0.48/0.6	1.1/1.3	0.44/0.54	1.0/1.2	0.41/0.54	0.9/1.2	0.39/0.54	0.9/1.2	0.37/0.49	0.8/1.1	0.34/0.45	0.8/1.0
Battery																												
6.01	Battery voltage/Capacity				80/271		80/271		80/271		80/271		80/202		80/202		80/404		80/404		80/404		80/404		80/272		80/272	
6.02	Battery weight		kg	lb	220	440	220	440	220	440	220	440	220	440	220	440	350	700	350	700	350	700	350	700	350	700	350	700

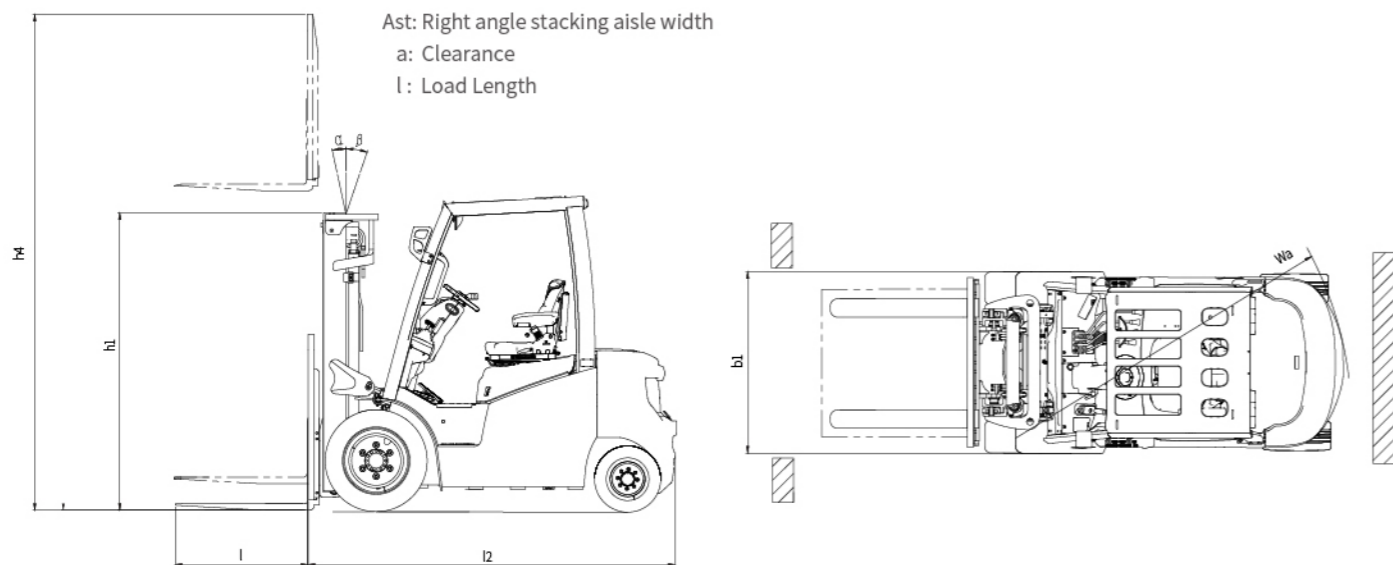

Note : for configuration number, 2:ZAPI controller;3:Inmotion controller.

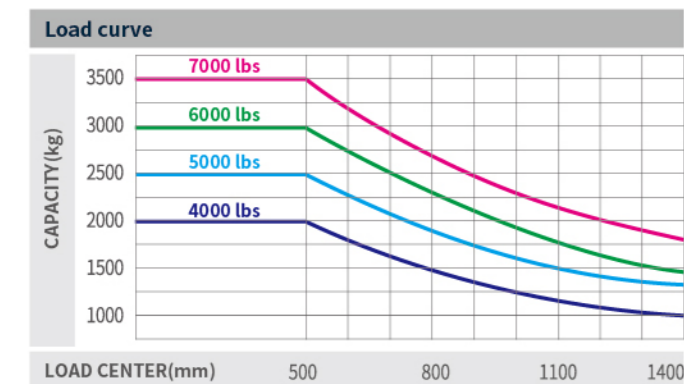

**Note:**The vertical axis stands for load capacity and the horizontal axis stands for load center which is calculated from the front surface of the forks to the gravity of the standard load. the standard load means a cubic with 1000mm edge length. When mast is tilted forward, using non-standard forks or loading large goods, the load capacity will be reduced. The load capacity of standard mast at different load center can be known from this load chart.

Lithium battery								
Lithium battery brand	Pengcheng (CATL module/Core)				Heli(LISHEN module/Core)			
	80V/202Ah	80V/271Ah	80V/404Ah	80V/542Ah	80V/202Ah	80V/272Ah	80V/404Ah	80V/544Ah
4000-5000 lbs S model	○	○	○	—	●	○	○	—
4000-5000 lbs M model	—	●	○	—	—	○	○	—
4000-5000 lbs H model	—	●	○	—	—	○	○	—
6000-7000 lbs S model	—	○	○	○	—	●	○	○
6000-7000 lbs M model	—	—	●	○	—	—	○	○
6000-7000 lbs H model	—	—	●	○	—	—	○	○
Lithium battery heating in low temperature	●							

NOTE: "●" standard ; "○" optional ; "—" not applicable

Color Options (the color of truck body can be customized)			
Model	H	M	S
Standard Configuration			



Wide View Standard Mast 4000-5000 lbs																			
Mast model	Max.lifting height		Load capacity (lode center 500mm)				Height (mast lowered)				Free lift (with backrest)				Service weight				Mast tilt angle α/β (°)
			2t		2.5t		2t		2.5t		2t		2.5t		2t		2.5t		
			mm	in	kg	lb	kg	lb	mm	in	mm	in	mm	in	mm	in	kg	lb	
M200	2000	79	2000	4000	2500	5000	1500	59	1500	59	150	6	150	6	3420	7540	3800	8378	6-12
M250	2500	98	2000	4000	2500	5000	1750	69	1750	69	150	6	150	6	3465	7639	3845	8477	6-12
M300	3000	118	2000	4000	2500	5000	2000	79	2000	79	150	6	150	6	3510	7738	3890	8576	6-12
M330	3300	130	2000	4000	2500	5000	2150	85	2150	85	150	6	150	6	3537	7798	3917	8636	6-12
M350	3500	138	2000	4000	2500	5000	2250	89	2250	89	150	6	150	6	3555	7837	3935	8675	6-12
M370	3700	146	2000	4000	2500	5000	2350	93	2350	93	150	6	150	6	3573	7877	3953	8715	6/6
M400	4000	157	2000	4000	2500	5000	2550	100	2550	100	150	6	150	6	3650	8047	4030	8885	6/6
M425	4250	167	1950 *2000	3900 *4000	2450 *2500	4900 *5000	2675	105	2675	105	150	6	150	6	3673	8098	4053	8935	6/6 *6/12
M450	4500	177	1900 *1950	3800 *3900	2300 *2400	4600 *4800	2800	110	2800	110	150	6	150	6	3695	8146	4075	8984	6/6 *6/12
M500	5000	197	1800 *1850	3600 *3700	1850 *2000	3700 *4000	3050	120	3050	120	150	6	150	6	3740	8245	4120	9083	6/6 *6/12
M550	5500	217	1400 *1600	2800 *3200	1550 *1950	3100 *3900	3350	132	3350	132	150	6	150	6	3835	8455	4215	9292	3/6 *3/6
M600	6000	236	950 *1500	1900 *3000	1050 *1800	2100 *3600	3600	142	3600	142	150	6	150	6	3880	8554	4260	9392	3/6 *3/6

Note: (1) \* refers to the rate capacity when the front wheel of the truck is dual tyre.  
(2) When the front wheel of 4000-5000 lbs is dual tyre, the weight is the data in the table plus 100kg;

Wide View Standard Mast 6000-7000 lbs																			
Mast model	Max.lifting height		Load capacity (lode center 500mm)				Height (mast lowered)				Free lift (with backrest)				Service weight				Mast tilt angle α/β (°)
			3t		3.5t		3t		3.5t		3t		3.5t		3t		3.5t		
			mm	in	kg	lb	kg	lb	mm	in	mm	in	mm	in	mm	in	mm	in	
M200	2000	79	3000	6000	3500	7000	1570	62	1620	64	155	6	160	6	4484	9886	4894	10789	6-12
M250	2500	98	3000	6000	3500	7000	1820	72	1870	74	155	6	160	6	4532	9991	4947	10906	6-12
M300	3000	118	3000	6000	3500	7000	2070	81	2120	83	155	6	160	6	4580	10097	5000	11023	6-12
M330	3300	130	3000	6000	3500	7000	2220	87	2270	89	155	6	160	6	4609	10161	5032	11094	6-12
M350	3500	138	3000	6000	3500	7000	2320	91	2370	93	155	6	160	6	4628	10203	5053	11140	6-12
M370	3700	146	3000	6000	3500	7000	2420	95	2470	97	155	6	160	6	4647	10245	5074	11186	6/6
M400	4000	157	3000	6000	3500	7000	2620	103	2670	105	155	6	160	6	4727	10421	5158	11371	6/6
M425	4250	167	2850 *2900	5700 *5800	3300 *3400	6600 *6800	2745	108	2795	110	155	6	160	6	4751	10474	5184	11429	6/6 *6/12
M450	4500	177	2750 *2850	5500 *5700	3150 *3350	6300 *6700	2870	113	2920	115	155	6	160	6	4775	10527	5211	11488	6/6 *6/12
M500	5000	197	2400 *2600	4800 *5200	2700 *2850	5400 *5700	3120	123	3170	125	155	6	160	6	4823	10633	5264	11605	6/6 *6/12
M550	5500	217	1850 *2400	3700 *4800	2200 *2650	4400 *5300	3420	135	3470	137	155	6	160	6	4921	10849	5368	11834	3/6 *3/6
M600	6000	236	1500 *2200	3000 *4400	1650 *2400	3300 *4800	3670	144	3720	146	155	6	160	6	4969	10955	5421	11951	3/6 *3/6

Note: (1) \* refers to the rate capacity when the front wheel of the truck is dual tyre.  
(2) When the front wheel of 6000-7000 lbs is dual tyre, the weight is the data in the table plus 100kg;

Wide View Full Free 2-Stage Mast 4000-5000 lbs																			
Mast model	Max.lifting height		Load capacity (lode center 500mm)				Height (mast lowered)				Free lift (with backrest)				Service weight				Mast tilt angle α/β (°)
			2t		2.5t		2t		2.5t		2t		2.5t		2t		2.5t		
			mm	in	kg	lb	kg	lb	mm	in	mm	in	mm	in	mm	in	kg	lb	
ZM200	2000	79	2000	4000	2500	5000	1500	59	1500	59	496	20	496	20	3432	7566	3812	8404	6-12
ZM250	2500	98	2000	4000	2500	5000	1750	69	1750	69	746	29	746	29	3480	7672	3960	8730	6-12
ZM300	3000	118	2000	4000	2500	5000	2000	79	2000	79	996	39	996	39	3527	7776	3907	8613	6-12
ZM330	3300	130	2000	4000	2500	5000	2150	85	2150	85	1146	45	1146	45	3557	7842	3937	8680	6-12
ZM350	3500	138	2000	4000	2500	5000	2250	89	2250	89	1246	49	1246	49	3575	7882	3955	8719	6-12
ZM370	3700	146	2000	4000	2500	5000	2350	93	2350	93	1346	53	1346	53	3595	7926	3975	8763	6/6
ZM400	4000	157	2000	4000	2500	5000	2550	100	2550	100	1546	61	1546	61	3671	8093	4051	8931	6/6
ZM425	4250	167	1950 *2000	3900 *4000	2450 *2500	4900 *5000	2675	105	2675	105	1671	66	1671	66	3695	8146	4075	8984	6/6 *6/12
ZM450	4500	177	1900 *1950	3800 *3900	2300 *2400	4600 *4800	2800	110	2800	110	1796	71	1796	71	3721	8203	4101	9041	6/6 *6/12
ZM500	5000	197	1800 *1850	3600 *3700	1850 *2000	3700 *4000	3050	120	3050	120	2046	81	2046	81	3772	8316	4152	9154	6/6 *6/12
ZM550	5500	217	1400 *1600	2800 *3200	1550 *1950	3100 *3900	3350	132	3350	132	2346	92	2346	92	3869	8530	4249	9367	3/6 *3/6
ZM600	6000	236	950 *1500	1900 *3000	1050 *1800	2100 *3600	3600	142	3600	142	2596	102	2596	102	3919	8640	4299	9478	3/6 *3/6

Note: (1) \* refers to the rate capacity when the front wheel of the truck is dual tyre.  
(2) When the front wheel of 4000-5000 lbs is dual tyre, the weight is the data in the table plus 100kg;  
(3) 4000-5000 lbs: The free lifting height is increased by 356 mm when there is no backrest;

Wide View Full Free 2-Stage Mast 6000-7000 lbs																			
Mast model	Max.lifting height		Load capacity (lode center 500mm)				Height (mast lowered)				Free lift (with backrest)				Service weight				Mast tilt angle α/β (°)
			3t		3.5t		3t		3.5t		3t		3.5t		3t		3.5t		
			mm	in	kg	lb	kg	lb	mm	in	mm	in	mm	in	mm	in	mm	in	
ZM200	2000	79	3000	6000	3500	7000	1570	62	1620	64	340	13	443	17	4505	9932	4911	10827	6-12
ZM250	2500	98	3000	6000	3500	7000	1820	72	1870	74	590	23	693	27	4555	10042	4964	10944	6-12
ZM300	3000	118	3000	6000	3500	7000	2070	81	2120	83	840	33	943	37	4605	10152	5018	11063	6-12
ZM330	3300	130	3000	6000	3500	7000	2220	87	2270	89	990	39	1093	43	4637	10223	5051	11136	6-12
ZM350	3500	138	3000	6000	3500	7000	2320	91	2370	93	1090	43	1193	47	4657	10267	5072	11182	6-12
ZM370	3700	146	3000	6000	3500	7000	2420	95	2470	97	1190	47	1293	51	4677	10311	5093	11228	6/6
ZM400	4000	157	3000	6000	3500	7000	2620	103	2670	105	1390	55	1493	59	4755	10483	5173	11405	6/6
ZM425	4250	167	2850 *2900	5700 *5800	3300 *3400	6600 *6800	2745	108	2795	110	1515	60	1618	64	4781	10540	5200	11464	6/6 *6/12
ZM450	4500	177	2750 *2850	5500 *5700	3150 *3350	6300 *6700	2870	113	2920	115	1640	65	1743	69	4809	10602	5229	11528	6/6 *6/12
ZM500	5000	197	2400 *2600	4800 *5200	2700 *2850	5400 *5700	3120	123	3170	125	1890	74	1993	78	4863	10721	5285	11651	6/6 *6/12
ZM550	5500	217	1850 *2400	3700 *4800	2200 *2650	4400 *5300	3420	135	3470	137	2190	86	2293	90	4962	10939	5388	11879	3/6 *3/6
ZM600	6000	236	1500 *2200	3000 *4400	1650 *2400	3300 *4800	3670	144	3720	146	2440	96	2543	100	5015	11056	5444	12002	3/6 *3/6

Note: (1) \* refers to the rate capacity when the front wheel of the truck is dual tyre.  
(2) When the front wheel of 6000-7000 lbs is dual tyre, the weight is the data in the table plus 100kg;  
(3) 6000 lbs: The free lifting height is increased by 520mm when there is no backrest;  
(4) 7000 lbs: The free lifting height is increased by 426 mm when there is no backrest;

Wide View Full Free 3-Stage Mast 4000-5000 lbs																			
Mast model	Max.lifting height		Load capacity (lode center 500mm)				Height (mast lowered)				Free lift (with backrest)				Service weight				Mast tilt angle α/β (°)
			2t		2.5t		2t		2.5t		2t		2.5t		2t		2.5t		
			mm	in	kg	lb	kg	lb	mm	in	mm	in	mm	in	mm	in	kg	lb	
ZSM360	3600	142	2000	4000	2500	5000	1800	71	1800	71	796	31	796	31	3654	8056	4034	8893	6/6
ZSM400	4000	157	2000	4000	2500	5000	1950	77	1950	77	946	37	946	37	3695	8146	4075	8984	6/6
ZSM435	4350	171	1900 *2000	3800 *4000	2400 *2500	4800 *5000	2050	81	2050	81	1046	41	1046	41	3726	8214	4106	9052	6/6 *